



NORMAGRUP  
POCKET  
SOLUTIONS

For a  
reliable  
world



salUZ<sup>®</sup> UV-C

Disinfecting technology

**NORCLINIC**

by Normagrup





Health is one of our priorities when we design and create our products. This is how SaLuz®, our healthy lighting range, has been born. SaLuz is a range that implements all the research we have made to create healthier environments.



With **Trazzo SaLuz® UV-C** we are introducing a new **device** that emits ultraviolet radiation to **eliminate virus, bacteria and pathogens**. This way, it is possible to disinfect and sterilize any site effortlessly and without using any chemicals.

**Direct ultraviolet radiation (254 nm)** is a germicide solution for enclosed spaces that can remove viruses (including Covid-19), bacteria and pathogens at a 99.9% efficiency rate.

Due to the low penetration of UV-C radiation, it can only disinfect surfaces at sight of the device, so it can be considered as a device to decrease the viral or bacterial load.

\*Based on the exposure time.

## Ultraviolet radiation to prevent the spread of microorganisms

# What is ultraviolet radiation (UV)?

Ultraviolet radiation (UV) is an electromagnetic energy that is broadcasted at wavelengths that are out of the visible spectrum and, hence, invisible for the human eye. More specifically, it is ranged between the visible spectrum and the X rays.

Ultraviolet radiation is used to treat water, air or surfaces biologically contaminated.

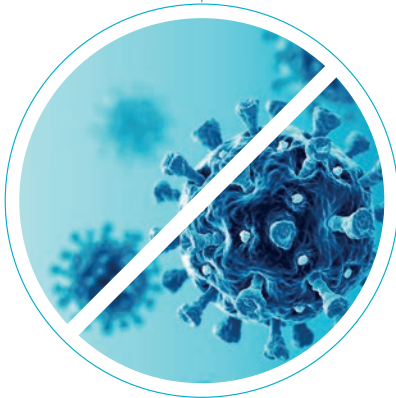
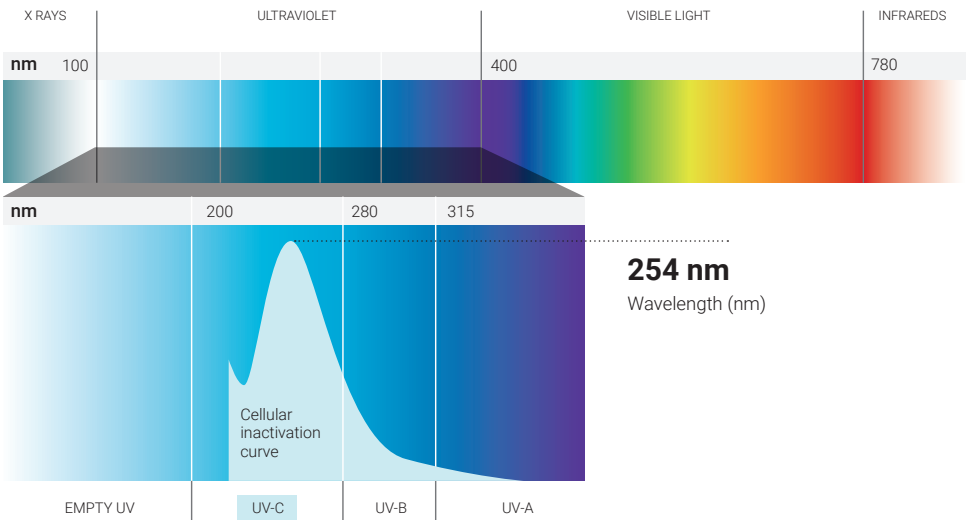

One of its unique features is that in a specific interval of its wavelengths (**between 200 and 300 nanometres**) it works as a germicide, which means that it can inactivate microorganisms such as bacteria, viruses and protozoos. This capacity has enabled the general use of UV radiation as an environmentally friendly, efficient, and chemical free way to disinfect.

# How does a UV-C luminaire disinfect?

UV radiation quickly inactivates efficiently all the microorganisms through a physical process: **when viruses, bacteria, germs, algae or spores are exposed to the germicide ultraviolet radiation wavelengths, they die or are unable to reproduce.**

Microorganisms are deactivated through UV radiation as a result of the damage to their nucleic acids. DNA and cellular RNA absorb the high energy associated with short wavelength UV energy, mainly at 254 nm.

The use of UV-C radiation can cause degradation in plastic materials, fabrics, paintings, etc.

**99.9%**

**effectiveness against microorganisms**

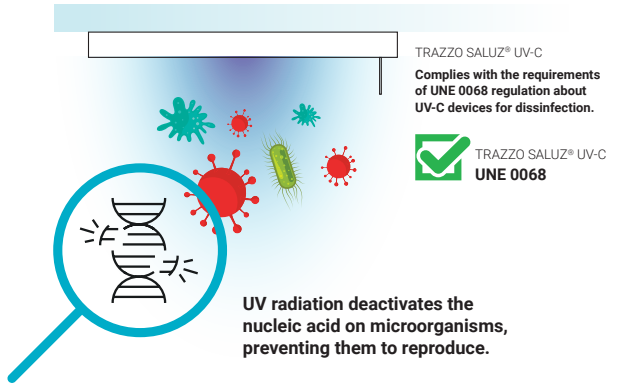

Please consider that this type of technology may damage humans or animals.

It has been scientifically proven that high accidental exposure to high levels of UV radiations coming from UV-C devices can cause skin or eye problems in humans.

The site must be empty while SaLuz® disinfecting system is in progress.

**Normagrup cannot be made liable for any consequences from the incorrect use or installation of this device.**



# Trazzo SaLuz® UV-C

To guarantee security, Trazzo SaLuz® UV-C includes several security and warning mechanisms that alert that the device is in operation and automatically stop it if they detect any person or animal within its action scope.

## Occupancy detector incorporated

Detector classified as a functional security sensor with a **detection area of Ø 6m.**

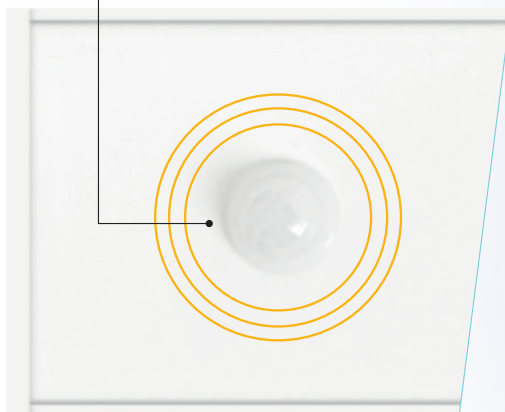

## To avoid losing efficiency, it does not include any cover.

UV-C radiation is filtered through almost any material. Conventional materials such as glasses, polycarbonates or methacrylates filter completely this radiation.

## Bright warning of beginning of disinfection

This warning will remain active during all the disinfection process carried out by the device.

## Replaceable UV-C germicide light source

Useful life 9,000 hours.

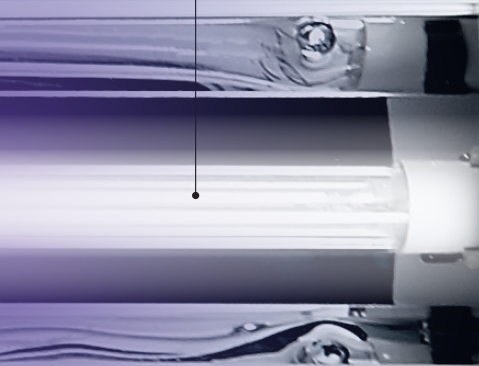

## Audible warning of beginning of disinfection (80 db)

This warning will remain active during all the disinfection process carried out by the device.





## How it works

# Trazzo SaLuz® UV-C

## Removes viruses, protects people

Radiation levels from UV-C lamps may damage eyes or skin. For this reason, and to make sure that there is nobody on site while the luminaire is in operation, Trazzo SaLuz® UV-C includes several security measures according to UNE 0068 specification.

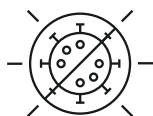

**A bright and audible intermitent sign will warn for one minute before it gets started.**

When the luminaire is powered, the audible alert and the bright sign will warn intermitently (1 second) of the beginning of the disinfection. This warning will last for one minute.



**While disinfection is in progress, Trazzo SaLuz® UV-C emits a sound and an intermitent bright warning alert.**

After the first warning, the luminaire will turn on and will start disinfecting within its area of action (see area table). The luminous sign will be blinking while the luminaire is on, and the acoustic sign will be also on.





**And to increase security, Trazzo SaLuz® UV-C includes an occupancy detector (detection area of Ø 6m.) that switches off the luminaire in case there is anybody within its scope of action.**

As a security measure, the occupancy detector will switch off the light source, so it will stop disinfecting if it detects any presence within its scope of action. The luminaire will reactivate after 30 seconds without detecting any presence.



## Applications

# The essential solution for many areas

There are many areas that require maximum hygiene and sterilization. Trazzo Saluz® UV-C achieves this efficiently without any human intervention, which minimizes contamination possibilities.

Some of the usual applications are:

### Hospitals, clinic buildings or any other health related centre:

Operating theatres, emergency wards, dentists, veterinaries, physiotherapists, optician clinics, etc.

### Public places

From schools and customer service offices, to airports, sports centres, theatres or places of worship.

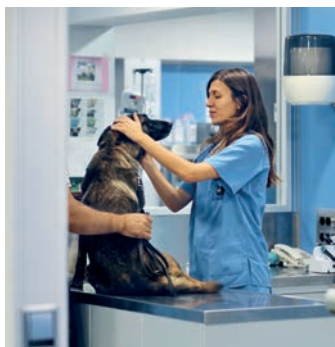



Site protected with  
UVC disinfection  
system

SaLUZ<sup>®</sup> UVC



In order to convey confidence and peace of mind, **each Trazzo SaLuz<sup>®</sup> UVC includes an adhesive** that can be placed at the entrance of any site or also within its scope of action.

Summarizing, any space, building or industry that needs to guarantee maximum levels of hygiene and sterilization.

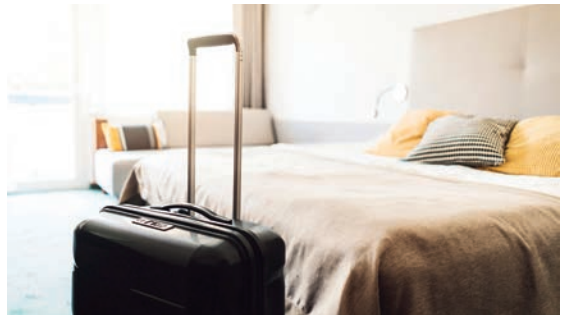

## Installation

# Design and versatility

Trazzo SaLuz® UV-C is a solution that will adapt easily to every space, being able to adapt multiple configurations: surface mounted, embedded or suspended.

### Installation possibilities

---

Surface mounted

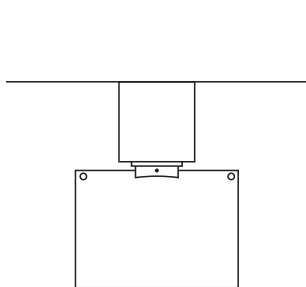

Embedded

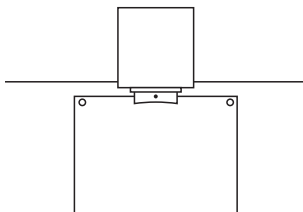

Suspended

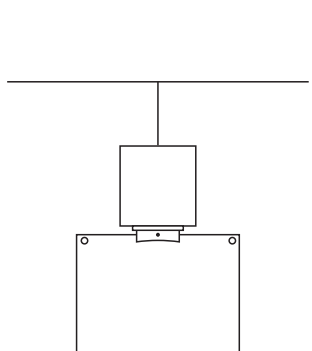



### Installation height

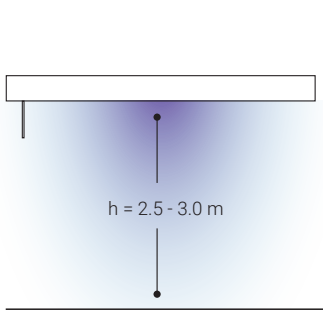



### Dissinfection time

### Dissinfection area

### Number of SaLuz® UV-C fittings

Dissinfection percentage

**90%**    **99.9%**

Dissinfection time	Dissinfection area	90%	99.9%
 <b>60 min.</b>	Up to 30 m <sup>2</sup>	1x	1x
	Between 30 and 80 m <sup>2</sup>	1x	2x
 <b>30 min.</b>	Up to 30 m <sup>2</sup>	1x	1x
	Between 30 and 80 m <sup>2</sup>	1x	3x
 <b>15 min.</b>	Up to 30 m <sup>2</sup>	1x	2x
	Between 30 and 80 m <sup>2</sup>	1x	4x

It is possible to include a timer in the system.

Indicative data, ask our project department for a calculation at: [projectos@normagrup.com](mailto:projectos@normagrup.com)

## Installation

# Trazzo salUZ® UV-C

SURFACE  
MOUNTED



SUSPENDED

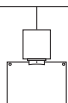





EMBEDDED

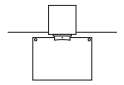

## Technical information

### Trazzo salUZ® UV-C

TRAZZO SALUZ® UV-C is a linear device for surface mounted, embedded or suspended installation. Made of extruded aluminium with 1000mm lenght. It is equipped with a UV radiation (254nm) that acts as germicidal for disinfection and sterilization.

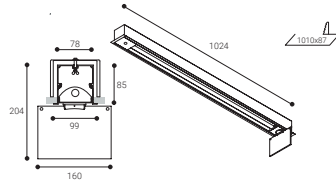
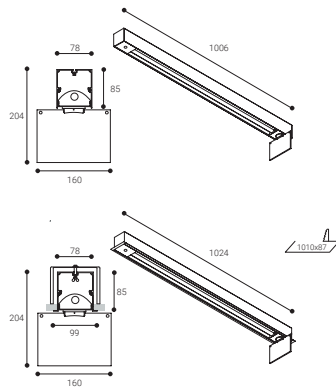

INSTALLATION		W	COLOUR	L(mm)	
Surface mounted	T7AUVC075B	1x75W	○	1006	2,5
	T7AUVC075N	1x75W	●	1006	2,5
	T7AUVC075G	1x75W	⊙	1006	2,5
Suspended	T7SUV075B	1x75W	○	1006	2,5
	T7SUV075N	1x75W	●	1006	2,5
	T7SUV075G	1x75W	⊙	1006	2,5
Embedded	T7EUVC075B	1x75W	○	1024	2,5
	T7EUVC075N	1x75W	●	1024	2,5
	T7EUVC075G	1x75W	⊙	1024	2,5

## Norms and regulations

SALUZ UV-C fittings comply with:

All the low voltage electrical equipments essential requirements prescribed in norm **2014/35/UE**.

- Norm **EN 60598-1:2015**, about luminaires.
- Norm **EN 60598-2-1:1993**, about particular requirements for luminaires.
- Norm **EN62471:2008**, about photobiological safety in lamps and devices using lamps.

All the essential requirements about electromagnetic compatibility prescribed in norm **2014/30/UE**.

- Norm **EN 55015:2013** about limits and measurements methods of radioelectric perturbations in lighting fittings or similar.
- Norm **EN 61000-3-2:2014** about electromagnetic compatibility (CEM). Limits for armonic current emissions (fittings with entry current smaller than 16A by phase)
- Norm **EN 61000-3-3:2013**, about electromagnetic compatibility (CEM). Limitation of voltage changes, voltage fluctuations and flickering in the public networks of low voltage (fittings with entry current smaller than 16A by phase and not subject to a conditional conection).
- Norm **61547:2011**, about fittings for general lighting. Requirements related to the CEM immunity.

All the essential requirements about the restrictions of dangerous substances in electrical devices prescribed in directive **2011/65/UE**.

All the essential requirements about waste of electrical and electronical equipment (RAEE) prescribed in directive **2012/19/UE**.

All the essential requirements about minimum safety and health dispossitions about workers being exposed to dangerous agents prescribed in directive **2006/25/CE**.

100% of production is tested, including the functioning and safety tests.



## References

---

Patogen dosis table



---

Nebraska Hospital protocol for  
dissinfecting masks during the  
COVID 19 crisis



---

Deactivation of viruses in  
surface by UV radiation,  
by Chun-Chieh Tseng and  
Chih-Shan Li







# NORCLINIC

Technical systems for hospitals  
[norclinic.com](http://norclinic.com)

Company certified on the international norms:  
ISO-EN9001 and ISO EN 13485



**100%**

Diseñado y fabricado  
íntegramente en España

*Entirely designed and  
manufactured in Spain*

## saLuz®

SaLuz® is a registered trademarks.

---

### Sede central / Headquarters

Parque Tecnológico de Asturias. C/ Ablanal, 1  
33428 Llanera (Asturias). España / Spain  
[normagrup.com](http://normagrup.com)

### Normagrup UK

Unit 5 Ninian Park  
Ninian Way  
Tame Valley  
Tamworth  
B77 5ES

### Normagrup Netherlands

Korte Huifakkerstraat 18  
4815 PS Breda, The Netherlands

### Normagrup France

27 Rue Edouard Lang  
76600 Le Havre  
France

### Normagrup Mexico

Gral. Mariano Escobedo 353-A of.502  
Col. Polanco Sección V  
Del. Miguel Hidalgo, CDMX  
C.O. 11570, México



**Normagrup**